

ELEVATION
SCALE : NONE

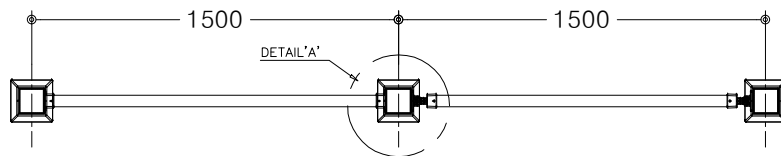

PLAN
SCALE : NONE

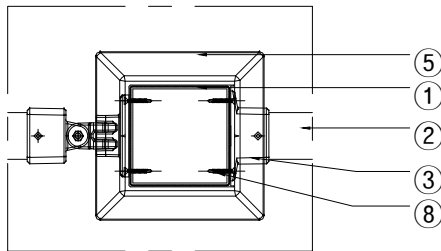

DETAIL 'A'
SCALE : NONE

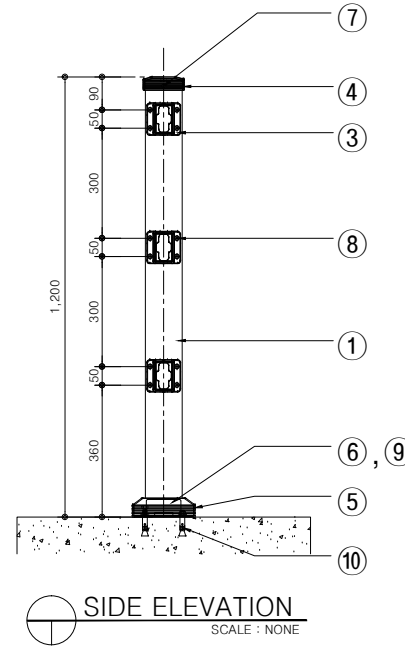

SIDE ELEVATION
SCALE : NONE

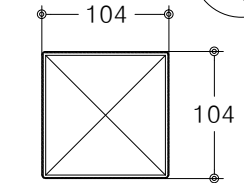
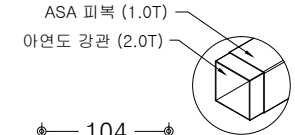

주주상세도
SCALE : NONE

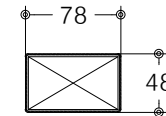
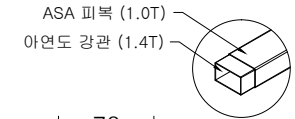

횡대상세도
SCALE : NONE

H=1,200 W=1,500

| NO | 품명 | 규격 | 단위 | 수량 | 재질 | 비고 |
|----|-----------|-----------------|----|------|--------------------------|----|
| 1 | 주주 | 100x100x2.0T | M | 1.2 | ASA 복합수지, KSD3568 SRT275 | |
| 2 | 횡대 | 75x45x1.4T | M | 4.2 | ASA 복합수지, KSD3568 SRT275 | |
| 3 | 브라켓 | 88x88x98 | EA | 6.0 | ASA 수지 | |
| 4 | 주주캡 | 113x113x37 | EA | 1.0 | ASA 수지 | |
| 5 | 하부캡 | 171x171x52 | EA | 1.0 | ASA 수지 | |
| 6 | 고정양카판 | 160x160x45x3.0T | EA | 1.0 | STEEL | |
| 7 | 접시머리 직결피스 | #8x16 | EA | 2.0 | STS410 | |
| 8 | 와셔머리 직결피스 | #8x16 | EA | 24.0 | STS410 | |
| 9 | 육각 직결피스 | #14x25 | EA | 2.0 | STS410 | |
| 10 | 양카-B/N | M12x100 | EA | 4.0 | STS304 | |

도면명
Drawing Title

ASA-ASF-01

설 계
Design by

날짜/
DATE

도면 번호

공사명
Project Title

제 도
Drawing by

축척/
SCALE

NONE

ASA (주) 아시아

전북 완주군 봉동읍 테크노밸리로 472

Tel : 063-263-8250~1 Fax : 063-263-8252

http://www.asiafence.co.kr E-mail : 2638250@naver.com